

## Design and Simulation of Neuro Fuzzy Controller for Speed Control of a Separately Excited dc Motor

Sharad Chandra Rajpoot<sup>1</sup>, Prashant Singh Rajpoot<sup>2</sup>, Premlata<sup>3</sup>, Durga Sharma<sup>4</sup>

<sup>1</sup>Assistant professor G.E.C. Jagdalpur, bastar, Chhattisgarh, India,

<sup>2</sup>Assistant professor, L.C.I.T., Bilaspur, Chhattisgarh, India,

<sup>3</sup>PG scholar, Dept of Electrical & Electronics Engineering, Dr.C.V. Raman Institute & science & Technology Bilaspur, Chhattisgarh, India,

<sup>4</sup>Assistant professor Dept of Electrical, Dr.C.V. Raman Institute & science & Technology Bilaspur, Chhattisgarh, India,

---

**Abstract:** DC machines play an important role in industries and in our daily life. DC machines applications involve reconsideration of their operating characteristics, together with their economic and technical evolution as compared with other competing energy conversion devices. The outstanding advantage of DC machines is that they offer easily controllable characteristics. Their main disadvantage is high initial investment. In spite of this DC machines still hold a strong competitive position for industrial applications because of their attractive features. Large DC motors are used in machine tools, printing press, conveyors, pumps, hoists cranes, paper mills and so forth. Small DC machines (in fractional horse power rating) are used primarily as control devices such as tacho-generators for speed sensing and servo motors for positioning and tracking. DC motors still dominate fractional motors used in transit cars and locomotives as torque speed characteristics of DC motors can be varied over a wide range while retaining high efficiency. DC motors possess excellent torque-speed characteristics and offer a wide range of speed control. Though efforts are being made to obtain wide range speed control with AC motors, yet the versatility and flexibility of DC motor can't be matched by AC motors. Thus, the demand for DC motors would continue undiminished even in future. With the advancement in technology artificial intelligence (AI) tools such expert system, Fuzzy logic, Neural Network and Neuro-Fuzzy are being used for design of controllers. In present work we design Neuro-Fuzzy controller to control the speed of separately excited DC motor.

**Index Terms:** D.C. machines, Separately excited D.C. motor, artificial intelligence (AI), Fuzzy logic, Neural Network, Neuro-Fuzzy controller

---

### I. Introduction

DC machine are very popular as its torque –speed characteristics can be varied over a wide range. These characteristics are highly dependent on load variation and thus there is an increasing need for a good controller. To perform tight regulation under high unpredictable load variations, The traditional solutions has been choosing linear control techniques usually based on frequency domain but this method has turned out occasionally inefficient and its behavior can be improved where operating conditions are far from the normal operation. DC machines may also work as brakes. The brake mode is a generator action but with the electrical power either regenerated or dissipated within the machine system, thus developing a mechanical braking effect. It also converts some electrical or mechanical energy to heat, but this is undesired. The major advantages of DC machines are easy speed and torque regulation. The major parts of any machine are the stationary component, the stator, and the rotating component, the rotor.[6]

#### 1.1 Motivation And Objective

Electrical machines play an important role in industry as well as our day-to-day life. They are used to generate electrical power in power plants and provide mechanical work in industries. They are also an indispensable part of our lives. The DC Machine is considered to be basic electric machines. Their efficiency has always been a consideration for improvement. With 1% improvement of the efficiency we can obtain a result in increased performance of the DC motor. The most important challenge to reduce motor power consumption is to properly vary the shaft speed of motors according to load requirement.. [17]DC machine definitely plays an important role in industry. DC machines are very popular as its torque-speed characteristics can be varied over a wide range. These characteristics are highly dependent on load variation and thus there an increasing need for a good controller to perform tight regulation under high unpredictable load variations.[9]The traditional solution has been choosing linear control techniques usually based on frequency domain, but this method has turned out to be occasionally inefficient and its behavior can be improved where the operating conditions are far from the

nominal operation. Many techniques have come to improve the performance of the motor. Most recently techniques like Artificial Intelligence tools such as Fuzzy Logic, Neural Networks have come for this purpose. During last few years there is vast research going in the field of Fuzzy Logic and Neural Networks. New research efforts are aimed at synthesizing Fuzzy Logic and Neural Networks. Neural Networks has advantages in areas such as learning, classification and optimization where as Fuzzy Logic has advantage in areas such reasoning on a high (semantics or linguistic) level.[16]The two techniques complement each other. Researchers utilize these two technologies in series, using one as pre-processor or post processor for other. Presently the combination of Neuro Fuzzy approach is one of the major areas of application. The Neuro Fuzzy controller provides better performance compared to the conventional and Fuzzy controller. The proposed Neuro Fuzzy controller for separately excited DC motor provides a better response.

The main objective of the project work is

1. To design a Neuro Fuzzy controller for speed control of a separately excited DC motor. To compare its performance with PID controller & Fuzzy controller.

Their methodology convey's three distinct features:-

- 1) A unified parameterized reasoning formulation.
- 2) An improved fuzzy clustering algorithm.
- 3) An efficient strategy of selecting significant system inputs and their membership functions. [11]

## II. Dc Motor

### 2.1 General Machine Background

In today's world, almost all land-based electrical power supply networks are AC systems of generation, transformation, transmission and distribution. Thus there is little need for large DC generators. Furthermore, AC motors are used in industries wherever they are suitable or can give appropriate characteristics by means of power electronic devices. Yet there remain important fields of application when the DC machines can offer economic and technical advantage. The wonderful thing about DC machines is its versatility.[7] A DC machine can operate as either a generator or a motor but at present its use as a generator is limited because of the widespread use of AC power. Large DC motors are used in machine tools, printing presses, conveyors, fans, pumps, hoists, cranes, paper mills, textile mills and so forth. Small DC machines (in fractional horsepower rating) are used primarily as control devices such as tacho-generators for speed sensing and servomotors for positioning and tracking. DC motors still dominate as traction motors used in transit cars and locomotives as the torque-speed characteristics of DC motor can be varied over a wide range while retaining high efficiency. The DC machine definitely plays an important role in industry.

### 2.2 Construction Of Dc Motor

DC motor is a synchronous motor with commutator. it is running at fixed speed with fixed frequency  $N_s = (120f/p)$  .main parts of dc motor is stator ,armature, yoke, field winding ,armature winding, commutator etc.dig.

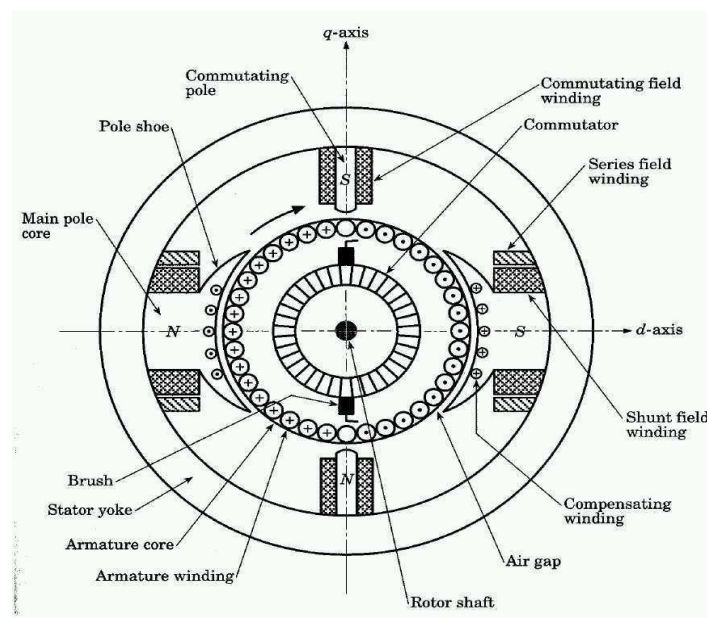

A) DC machine

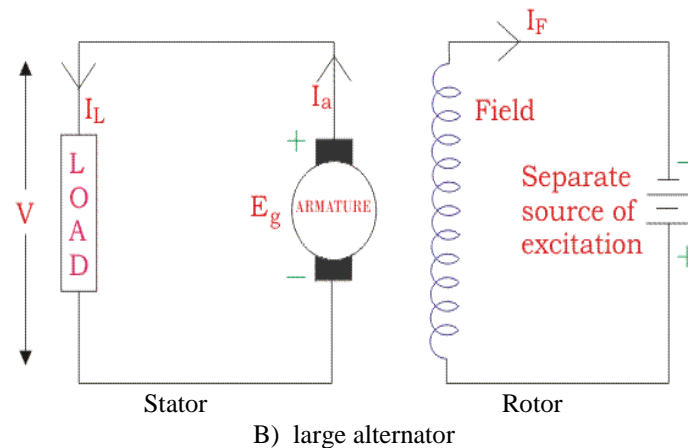

Filed winding is that winding in which flux induced & armature winding is that winding in which voltage is induced. In the case of DC machine either dc motor or dc generator always field winding is in stator and armature winding is in rotor, that is similar to small synchronous machine but just opposite to the large alternator because in that case the field winding is in the rotor in armature winding is in the stator. Dig.

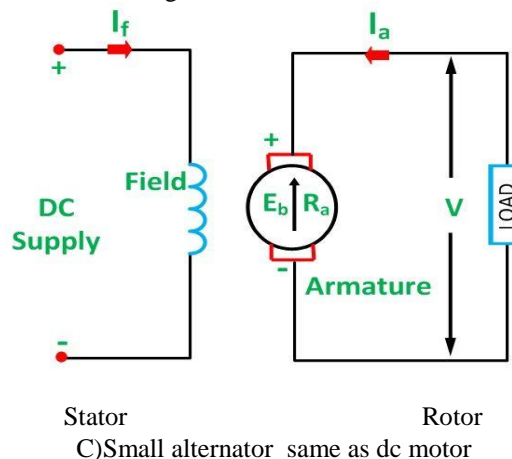

The stator of the DC motor has poles, which are excited by DC current to produce magnetic fields. The rotor has a ring-shaped laminated iron-core with slots. Coils with several turns are placed in the slots. The distance between the two legs of the coil is about 180 electric degrees. The coils are connected in series. To keep the torque on a DC motor from reversing every time the coil moves through the plane perpendicular to the magnetic field, a split-ring device called a commutator is used to reverse the current at that point. The commutator consists of insulated copper segments mounted in a cylinder.[20]The iron core is supported by a cast iron frame.The rotor iron core is mounted on the shaft. Coils are placed in the slots. The ends of the coils are bent and tied together to assure mechanical strength. The commutator mounted on the shaft consists of several copper segments, separated by insulation.. The segments in commutator are made out of copper and mica insulation. The end of each segment has a flag attached. The coil endings are welded to these flags. An insulated ring is placed on the coil ends to assure proper mechanical strength.[8]

### 2.3 Principle Of Opreration

it works on principle of electromagnetism. When ever a current caring stationary conductor is place near about presence of rotating magnetic field then a force acts on it, that is deflecting torque which is responsible for ration of the rotor of the motor. The direction of torque can be identify

The armature equation is shown below:

$$V_a = E_g + I_a R_a + L_a \frac{dI_a}{dt}$$

$$T_d = J \frac{dw}{dt} + B_w + T_l.$$

The torque equation is given by

Equation for back emf of motor will be:

$$E_g = K \Phi W$$

$$\text{Also, } T_d = K \Phi I_a$$

$$w = (V_a - I_a R_a) / K \Phi$$

Now, from the above equation it is clear that speed of DC motor depends on applied voltage, armature current, armature resistance and field flux. So, there are three ways of controlling speed of DC motor – armature voltage control, armature resistance control and field flux control .

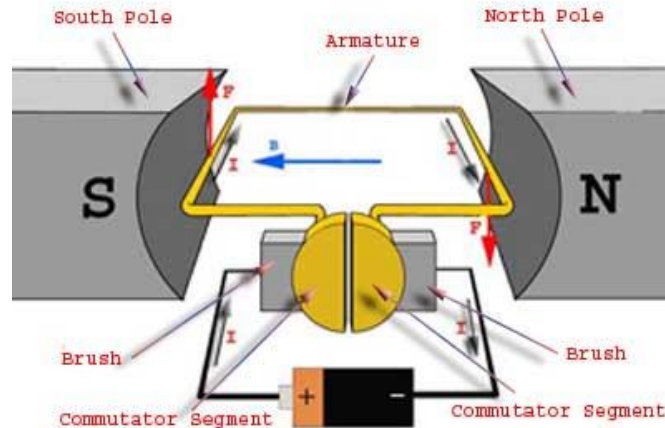

Fig. principle of operation of DC motor

When ever a current carrying stationary conductor is placed near about presence of rotating magnetic field then a force acts on it, that is deflecting torque which is responsible for rotation of the rotor of the motor. The direction of torque can be identified by using the Fleming's left hand rule. In any electric motor, operation is based on simple electromagnetism. A current carrying conductor generates a magnetic field which when placed in an external magnetic field; it will experience a force proportional to the current in the conductor and to the strength of the external magnetic field. The internal configuration of a DC motor is designed to harness the magnetic interaction between a current-carrying conductor and an external magnetic field to generate rotational motion.[14]The geometry of the brushes, commutator contacts, and rotor windings are such that when power is applied, the polarities of the energized winding and the stator magnet(s) are misaligned, and the rotor will rotate until it is almost aligned with the stator's field magnets.

As the rotor reaches alignment, the brushes move to the next commutator contacts, and energize the next winding. Current direction changes as the conductor passes through the neutral zone. The direction of magnetic field also changes as the conductor passes through the neutral zone. The direction of torque can be identified by using the Fleming's left hand rule.

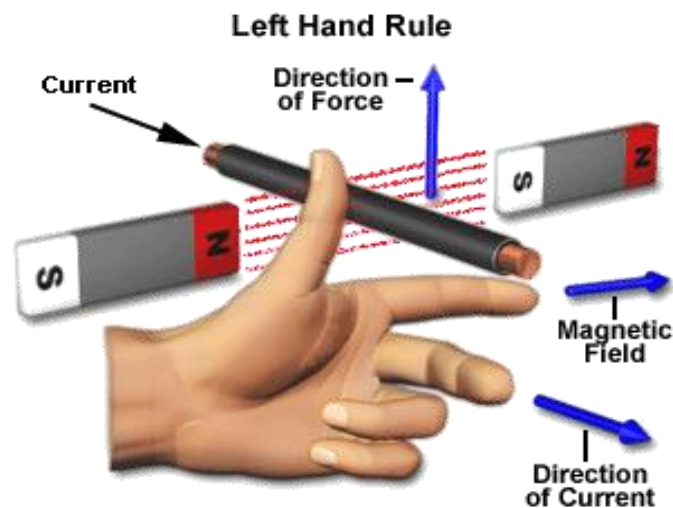
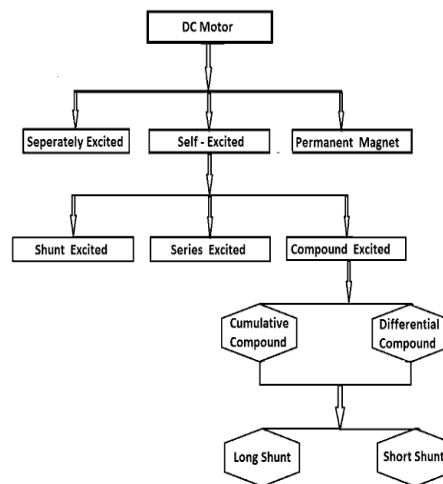

Fig. Fleming's left hand rule

### 3. Classification Of The Dc Motor



### 4. Separately Excited D.C. Motor

#### 4.1 Introduction

Separately excited D.C. motor is that motor in which the field winding is excited by the some external dc sources ,for example by the battery ,DC generator etc. as the name implies the field are energies by the separate DC sources. When a separately excited dc motor is excited by a field current  $I_f$  of and an armature current  $I_a$  of flows in the circuit, the motor develops a back EMF and a torque to balance the load torque at a particular speed. The field current  $I_f$  is independent of the armature current  $I_a$ . Each winding is supplied separately. Any change in the armature current has no effect on the field current . The  $I_f$  is generally much less than the  $I_a$ . Suppose  $V_a$  is the armature voltage in volt,  $I_a$  is the armature current in ampere,  $E_b$  is the motor back emf in volt,  $L_a$  is the armature inductance in Henry,  $R_a$  is the armature resistance in ohm.

The armature equation is shown below:

$$V_a = E_b + I_a R_a + L_a \frac{dI_a}{dt}$$

#### 4.1 Voltage Equation For The Separately Excited Dc Motor

the voltage  $V$  is applied across the motor armature has to

- 1) Overcome the back EMF  $E_b$
- 2) supply the armature ohmic drop  $I_a R_a$

$$V = E_b + I_a R_a$$

this is known as voltage equation of a separately excited DC motor.

Now , multiplying both sides by the  $I_a$  we get

$$V I_a = E_b I_a + I_a^2 R_a$$

$V I_a$  = electrical input to the armature

$E_b I_a$  = mechanical power developed in the armature

$I_a^2 R_a$  = cu loss in the armature.

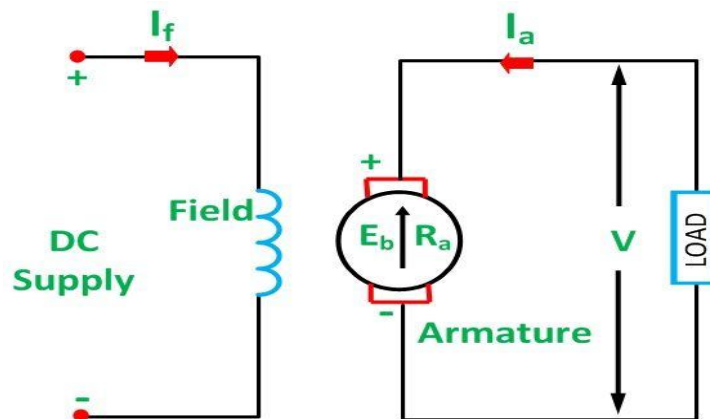

Fig. separately excited DC motor

#### 4.2 Importance Of The Back Emf

When the motor armature rotates, the conductors also rotate and hence cut the flux. In ac-conductance with the laws of electromagnetic induction ,EMF is induced in them whose direction ,as found by the Fleming’s right hand rule, is in opposition to the applied voltage. Because of it’s opposite direction, it is referred to as counter EMF or back EMF. the rotating armature generating the back EMF is like a battery of EMF.  $E_b$  put across the supply mains of  $V$  volts. Obviously,  $V$  has to drive  $I_a$  against the opposition of  $V$  volts. power required the overcome this opposition is  $E_b I_a$

### III. Neuro Fuzzy Systems.

#### 5.1 Introduction To Neural Control System

Neural control is the process used by the nervous system to control everything from movement to physiological processes. The body is a series of complex interconnected systems which work together to sustain life on a variety of ways, and neural control is the underpinning of these systems. Disorders of neural control are a topic of interest for some researchers and medical professionals who want to help people who have experienced damage to the brain or nervous system.[10]

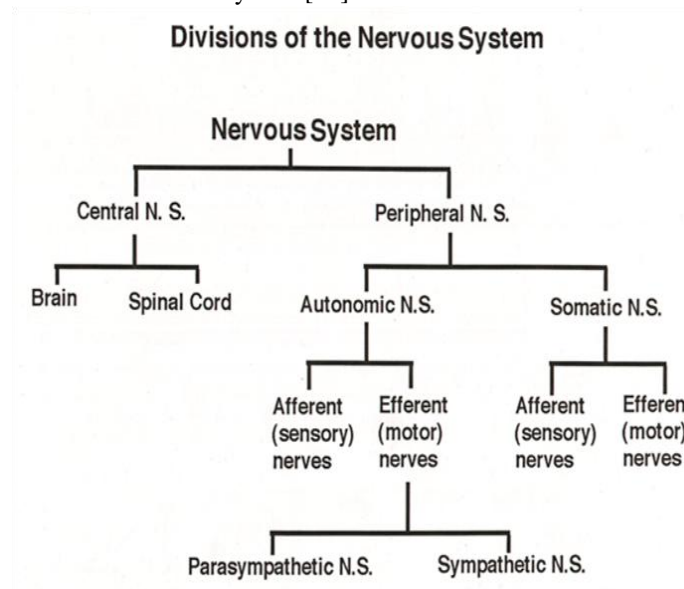

Fig. Nervous System

A **neural algorithm** commonly refers to a piece of code used in neural programming. This is where a neural network simulates specific behaviors and attributes of the human brain. Programmers talk about neural programming as a process evolved from older systems, where today's neural programming community builds on principles of artificial intelligence presented decades ago.

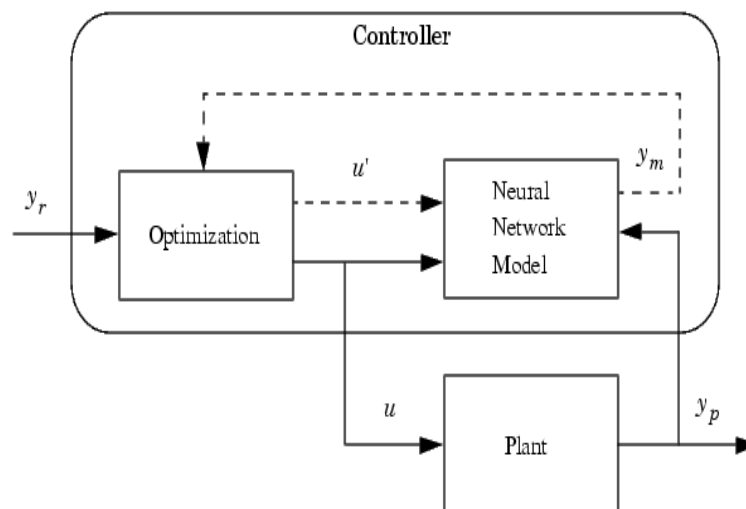

fig. Neural Control System

### 5.2 Introduction To Fuzzy Control Systems

Fuzzy logic is widely used in machine control. The term "fuzzy" refers to the fact that the logic involved can deal with concepts that cannot be expressed as the "true" or "false" but rather as "partially true". Although alternative approaches such as genetic algorithms and neural networks can perform just as well as fuzzy logic in many cases, fuzzy logic has the advantage that the solution to the problem can be cast in terms that human operators can understand, so that their experience can be used in the design of the controller. This makes it easier to mechanize tasks that are already successfully performed by humans.

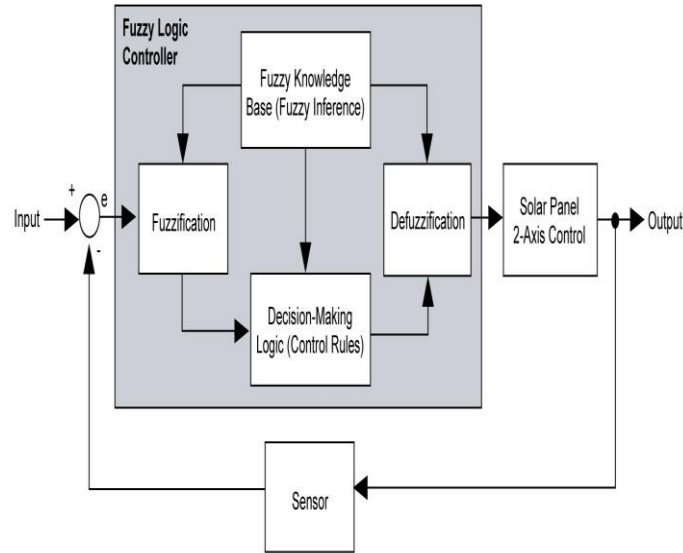

Fig. Fuzzy Control Systems

### 5.3 Fuzzy Neural Model Reference Controller

For the systems with changing parameters, the MRAC method gives a general approach for adjusting controller parameters so that the closed-loop transfer function will be close to a prescribed model[2]. Many algorithms employ a reference model to provide closed-loop performance feedback for synthesizing and tuning a fuzzy controller's knowledge-base. Consequently, these algorithms are referred to as a "Fuzzy Model Reference Learning Controller" (FMRLC). Fuzzy Neural Networks were also used instead of fuzzy systems, these algorithms denoted as "Fuzzy Neural Model Reference Controller" (FNMRC)[15]. The controller is designed such that the actual output of the process will track the desired output of the reference model. The MRAC is extensively used in neuro-fuzzy controllers due to its simplicity [16]. The block diagram in Figure 8 show the Speed control of Separately Excited DC Motor Using Fuzzy Neural Model Reference Controller with online tuned.

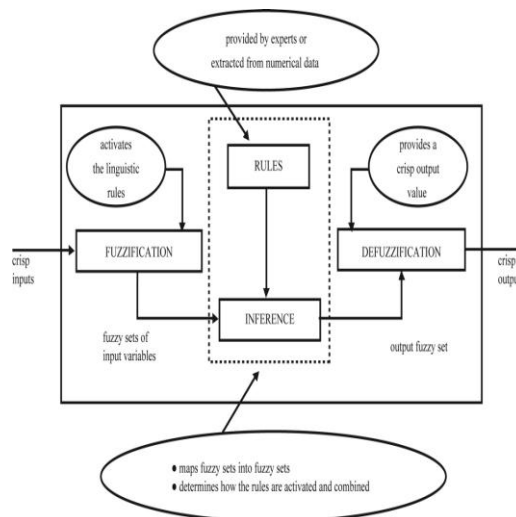

Fig. Schematic Diagram of a Neuro fuzzy system

### 6. Modeling Of Separately Excited Dc Motor

It will be proved that through torque of the motor is admittedly a function of flux and armature current. Yet it is independent of speed.

$$N = \frac{K (V - I_a R_a)}{\phi}$$

$$= \frac{K E_b}{\phi}$$

$$T_a \propto \phi I_a$$

DC motor there are basically 3 method of speed control. They are:-

- 1- Variation of resistance in armature circuit.
- 2- Variation of field flux.
- 3- Variation of armature terminal voltage.

In this work, principle of fuzzy logic and neuro fuzzy is incorporated for designing a speed controller of the dc drive. For carrying out the work, the simplified transfer function of separately excited dc motor is obtained [3]. We see that a separately excited dc motor, shown in figure . can be represented in block diagram by a controller and plant, controller is implemented before the plant to improve the performance.[25]

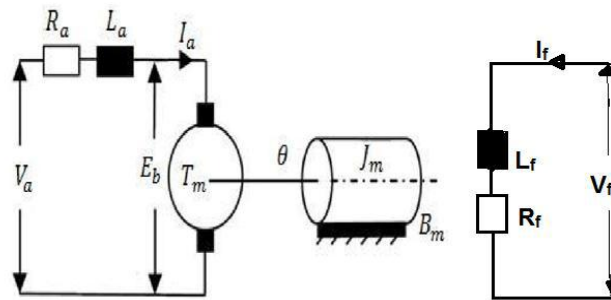

Fig. Separately excited DC motor model

Where

- Eb is back emf the motor (In volt)
- Ia is the armature current (In ampere)
- Ra is the armature resistance (In ohm)
- La is the armature inductance (In henry)
- Tm is the mechanical torque developed (In Nm)
- jm is moment of inertia (in kg/m<sup>2</sup>)
- Bm is friction coefficient of the motor (In Nm/ (rad/sec))
- ω is angular velocity (In rad/sec)

The equation below represents the transfer function of the plant under consideration.

$$P(s) = \frac{K}{J L_a s^2 + (f_0 L_a + J R_a) s + (f_0 R_a + K^2)}$$

Motor parameters obtained from a paper by Y.Tipsuwan and M.Y.Chow [3] are as follows: -

$$R_a = 4.67 \Omega \quad ; L_a = 8.463 \text{ H} \quad ; f_0 = 0.11723 \text{ Nm/rad/sec}$$

$$J = 0.10559 \text{ Kg m}^2 \quad ; K_T = 0.7318 \text{ Nm/A} \quad ; K_b = 0.7318 \text{ volts/rad/sec}$$

Transfer function of the plant is obtained as (La is not neglected here)

$$P(s) = \frac{0.7318}{0.8937s^2 + 1.485s + 1.3146}$$

Dynamics of a DC motor

Dynamics of a DC motor is described by the following equation:

$$K_p \omega(t) = -R i(t) - L \frac{di(t)}{dt} + V(t)$$

$$K_t i(t) = J \frac{d\omega(t)}{dt} + D \omega(t) + T_1(t) - T_f$$

where the parameters of the DC motor are in order to control a plant, a discrete time model of the plant is required. The following discrete time model of a DC motor is used:

$$V(K) = A_1 \omega(K+1) + A_2 \omega(K) + A_3 \omega(K-1) + A_4(K, K-1)$$



where  $k$  indicates the  $k$ th discrete time moment,  $A_1$ ,  $A_2$ , and  $A_3$  are real constants, and  $A_4$  is a real parameter which depends on the load of the motor.

Rate of error	Negative Big	Negative Small	Zero	Positive Small	Positive Big
Error					
Negative Big	Positive Big	Positive Big	Positive Small	Zero	Negative Small
Negative small	Positive Big	Positive Small	Positive Small	Negative Small	Negative Big
Zero	Positive Big	Positive Small	Zero	Negative Small	Negative Big
Positive Small	Positive Big	Positive Small	Negative Small	Negative Small	Negative Big
Positive Big	Positive Small	Zero	Negative Small	Negative Big	Negative Big

**Fig. Rule base**

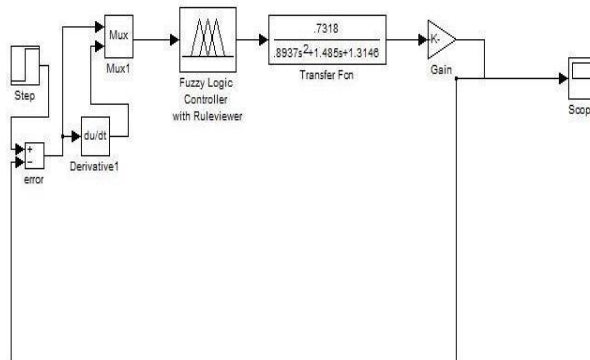

**Fig. Neuro fuzzy controller simulation in MATLAB for separately excited DC motor**

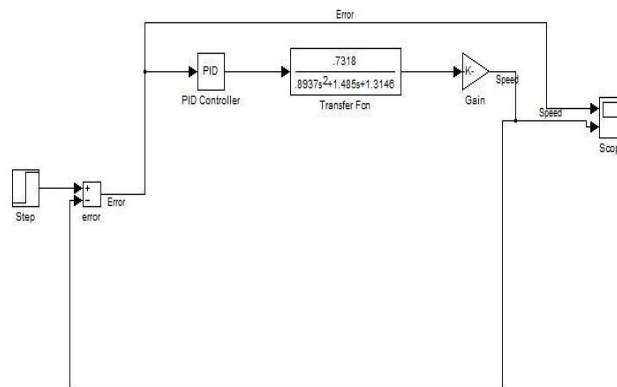

**Fig. PID Controller Simulation in MATLAB**

**IV. Results**

ANFIS tool is used to generate Neuro fuzzy outputs. Different membership function is used namely triangular, trapezoidal, gbell and gauss. The optimization used is hybrid .Neuro Fuzzy controller was used to control the DC motor speed with unit step input. The graphical responses of plant with PID controller, closed loop with fuzzy logic controller and Neuro Fuzzy controller has been shown below.

Type of membership function	Defuzification method	Peak overshoot Mpp (%)	Steady state error Ess	Rise time tr(sec)	Settling time ts(sec)
Trimf	Wtaver	1.02	0	2.68	5.41
Trapmf	Wtaver	1.02	0	3	6.06
Gbellmf	Wtaver	1.025	0	2.64	6.04
Gaussmf	Wtaver	1.03	0	2.55	6

**PID controller:-**

PID=1,1,1

Peakovershoot=1.12,Settling time=9.65,Rise time=4.2

**Triangular Membership Functions**

Defuzification method	Peak overshoot Mpp (%)	Steady state error Ess	Rise time tr (sec)	Settling time ts (sec)
Centroid	1.05	0	4.65	8.25
Bisector	1.03	0	4	7.25

**Trapezoidal Membership Functions**

Defuzification method	Peak overshoot Mpp (%)	Steady state error Ess	Rise time tr(sec)	Settling time ts(sec)
Centroid (4)	1.05	0	4.85	8.6
Bisector (5)	1.03	0	4.11	7.35

Graffs-

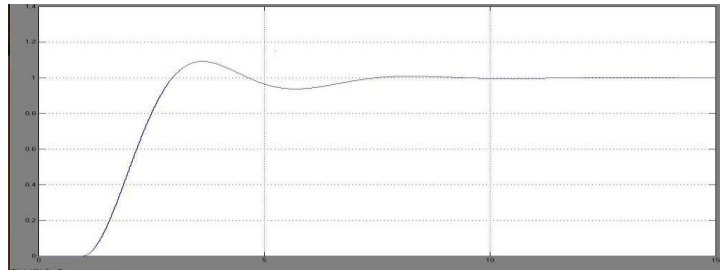

Output Response with P=1,I=1,D=1.

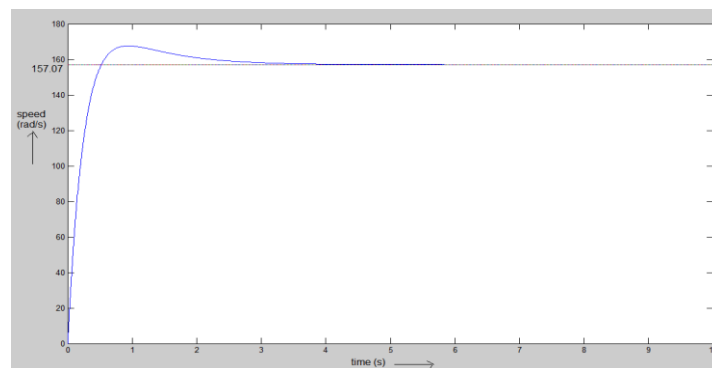

Speed Vs time response of fuzzy based PID controlled separately excited DC motor

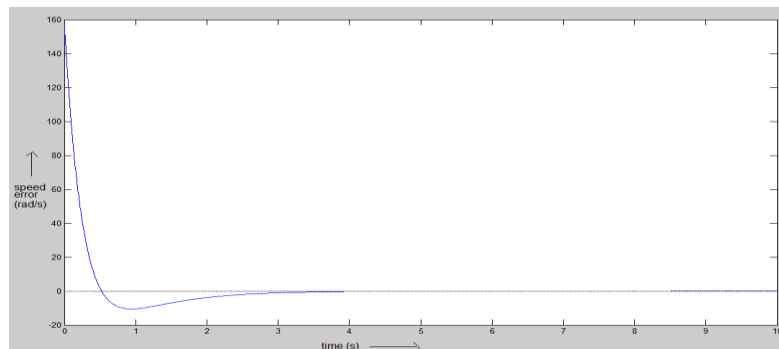

Output Response with P=4,D=0.2

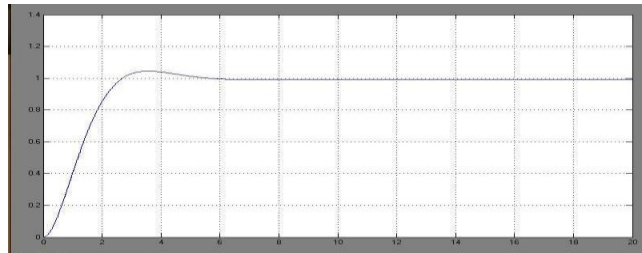

Output Response with ANFIS, trimf Time(s)

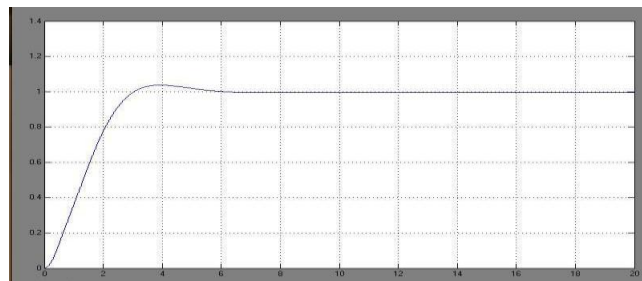

Output Response with ANFIS, trapmf Time(s)

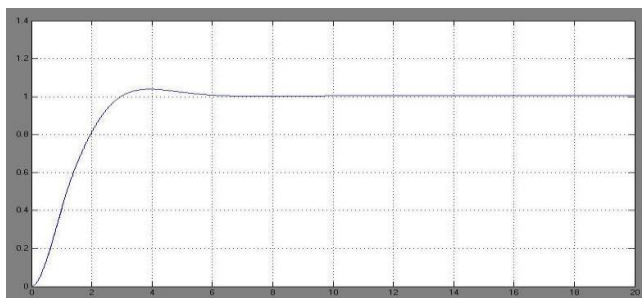

Time(s)

Output Response with Sugeno FIS Gaussmf,wtaver Defuzzification

## V. Conclusion

A Neuro Fuzzy controller has been designed for speed control of DC Motor. The simulations for the plant have been done using fuzzy toolbox in Matlab. The plant response has been compared using ANFIS, Fuzzy and PID controller. The settling time, rise time and peak overshoot have been compared using different controllers. The Neuro fuzzy controller has better response compared to fuzzy and PID. The peak overshoot, settling time are reduced and the response is fast for the Neuro Fuzzy controller.

### Future Scope

Neuro Fuzzy systems offer the precision and learning capability of neural networks, and are easy to understand like fuzzy systems. Explicit knowledge acquired from experts can be incorporated in a system, and implicit knowledge can be learned from training samples to enhance the accuracy of output. In this project a Neuro Fuzzy controller have been designed further new technologies such as Genetic algorithm, PSOC can be integrated to enhance the performance of the system.

## References

- [1]. K. Mudi and Nikhil R. Pal, IEEE Transaction on Fuzzy systems, Vol-7, no-1, Feb 1999 "A robust self tuning scheme for PI and PD type Fuzzy controller".
- [2]. Jihong Lee, IEEE Transaction on Fuzzy systems, Vol-1, no-4, Nov 1993 "On methods for improving performance of PI-type fuzzy logic controllers".
- [3]. Yodyium Tipsuwan and Mo-Yuen Chow, IEEE Transaction on Fuzzy systems, 1999, "Fuzzy logic microcontroller implementation for DC motor speed control".
- [4]. Emami, Burhan Turksen and Andrew A. Goldenberg, IEEE Transaction on Fuzzy systems, Vol-6, no-3, Aug 1998, "Development of a systematic methodology of fuzzy logic modeling".
- [5]. H.K.Lam, F.H.F.Laung and P.K.S.Tam, IEEE Transaction on Fuzzy systems, Vol-9, no-4, Aug 2001, "Non-Linear state feedback controller for non-linear systems: stability analysis and design based on fuzzy plant model".
- [6]. Soo Yeong Yi and Myung Jin Chung, IEEE Transaction on Fuzzy systems, Vol-6, no-2, May 1998 "Robustness of fuzzy logic control for an uncertain dynamic system".
- [7]. Eutani Kim, Minkee Park, Seunghwan Ji and Mignon Park, IEEE Transaction on fuzzy systems, Vol-5, no-3, Aug 1997 "A new approach to Fuzzy system".

- [8]. Li-Xin Wang, IEEE Transaction on automatic control, Vol-39, no-9, Sept 1994, "A supervisory controller for fuzzy control systems the guarantees stability".
- [9]. Hung-man and Fei-Yue Wang, IEEE Transaction on Fuzzy systems, Apr 1994, "Design of adaptive Neuro Fuzzy Controllers".
- [10]. Gurpreet S. Sandhu and Kuldip S. Rattan, IEEE Transaction on Fuzzy systems, Jan 1997, "design of neuro fuzzy controller".
- [11]. Kishan K. Kumbha and Mohammad Jamshidi, IEEE Transaction fuzzy systems, Jan 1997, "Real time control of direct drive motor by learning neuro fuzzy controller".
- [12]. Sang hoon, Kim, Lark Kyo, IEEE Transaction 2001, " design of neuro fuzzy controller for speed control applied to AC Servo motor".
- [13]. A.R.Sadeghian, IEEE 2001 International Fuzzy Systems Conference, " Nonlinear Neuro Fuzzy Prediction: Methodology, Design and Applications."
- [14]. Patrick B. Mo ratori, Adriano Joaquim de Oliveira Cruz, Leila Cristina V.de Andrade, Cabral Lima, IEEE 2005 Proceedings of fifth International Conference on Hybrid Intelligent Systems "Comparing Sensitivity and Robustness of Fuzzy and Neuro Fuzzy Controllers".
- [15]. Yodyium Tipsuwan, Saksira Aiemchareon, IEEE 2005, "A Neuro Fuzzy Network based Controller for Dc motor speed control".
- [16]. Carmadi Machbub, Ary Setijadi Prihatmanto, Yoseph Dwi Cahaya, IEEE PEDS 2001, "Design and Implementation of Adaptive Neural Networks Algorithm for DC motor speed control system using simple microcontroller".
- [17]. kanaka Durgamba, M.w.Cook, IEEE 1995, " A self learning neuro fuzzy controller".
- [18]. I.Rojas, J.L.bernier, M.Rodrigues Alvarez, A.Prieto, IEEE 2000, "What are main functional block involved in design of adaptive Neuro fuzzy inference systems?".
- [19]. Jyh-Shing, Rojer, Jang, IEEE transaction on systems, man, and cybernetics, Vol 23, No 3, may/june 1993, " ANFIS: adaptive network based fuzzy inference system".
- [20]. Yu yongquan, Huang ying, Zeng bi, IEEE international conference neural networks and signal processing, December 14-17, 2003, " A new method to construct the fuzzy controller using neural networks."
- [21]. Singari.v.s.r Pavankumar, Sande. krishnaveni, Y.B. Venugopal, Y.S.Kishore Babu, "A Neuro- Fuzzy
- [22]. Based Speed Control of Separately Excited DC Motor", IEEE Transactions on Computational Intelligence and Communication Networks, pp. 93-98, 2010.
- [23]. S. B. Dewan, Gordon R. Slemon, A. Straughen, "Power Semiconductor Drives", John Wiley & Sons, 1984.
- [24]. Moleykutty George, Kartik Prasad Basu, Alan Tan Wee Chiat, "Model reference controlled separately excited DC motor", Springer, Neural Comput & Application, vol. 19, Issue: 3, PP. 343- 351, 2010.
- [25]. Adel Elkeshet, "New Developments Using ANFIS for DC Motors Speed Control", MSc. Electrical and Computer Engineering, Dalhousie University, Canada, April, 2009.
- [25] Basma A. Omar, Amira Y. Haikal, Fayz F. Areed, "An Adaptive Neuro-Fuzzy Speed Controller for a Separately excited DC Motor", International Journal of Computer Applications, pp. 29-37, Vol. 39, No.9, February 2012.
- [26]. Salam Abdul Hady Abdul Kareem, "Fuzzy Neural And Fuzzy Neural Petri Nets Control For Robot Arm", MSc.Thesis, Computers Engineering, Basrah University , September, 2010.